

Flex Neon 220V 8,5W/m 10x16mm 120smd 300lm/m



Potencia

8.5W/m

Color de luz	6000K	SKU 4581
	4000K	SKU 4580
	2800K	SKU 4582
	Azul	SKU 4583
	Rojo	SKU 4584
	Verde	SKU 4585
	Amber	SKU 4586
	Amarillo	SKU 4587
	Rosa	SKU 4588
	RGB	SKU 4589

CE

RoHS

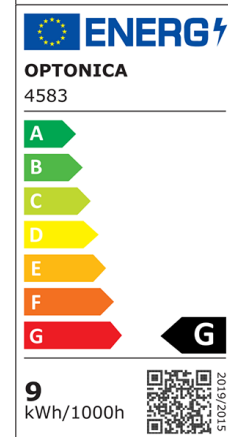
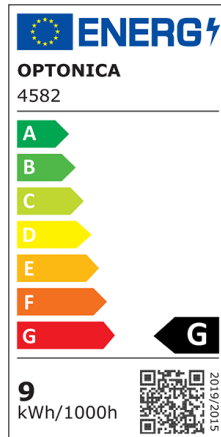
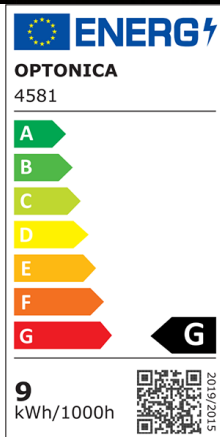
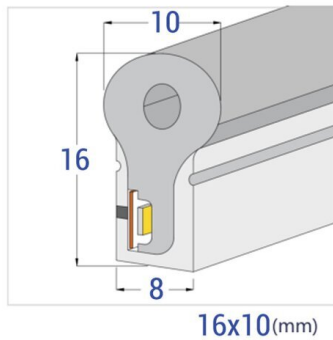

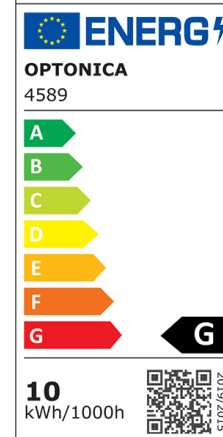
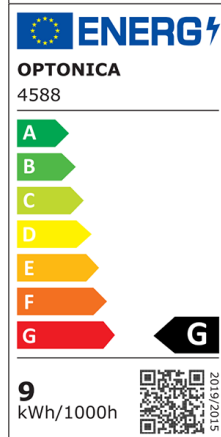
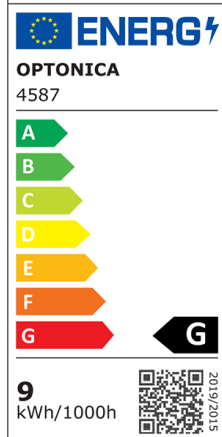
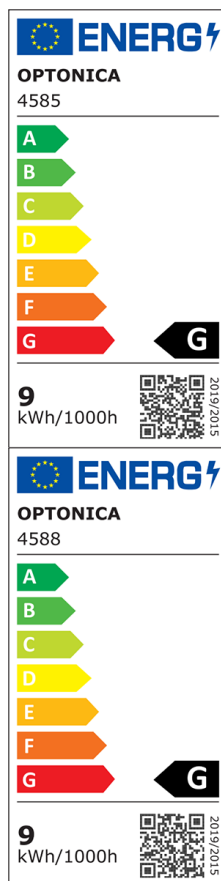
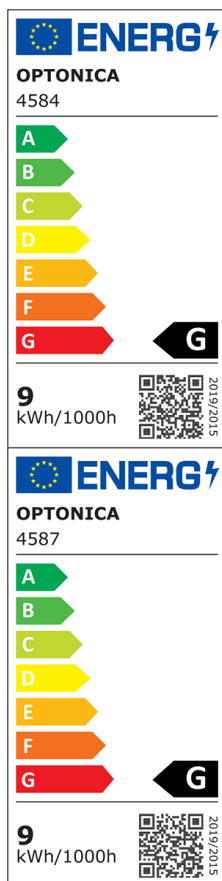

Especificaciones técnicas

Número de catálogo	4580-4589
Ángulo del haz de luz	120°
Marca	Optonica
Código de producto	ST220-A2
Dimensión	16x10 mm
Regulable	Yes
Etiqueta de eficiencia energética	G

Voltaje de entrada	AC: 220V
Instant On	0.2s
IP	65
Destello	300 lm/m
LEDs/m	120
Tipo de LED	SMD
Esperanza de vida	25 000 Hours
Flujo luminoso residual al final del período de funcionamiento	70%
Material	Flex PCB
Ciclos de encendido / apagado	25 000x
Frecuencia de operación	50-60Hz
Potencia por metro	8.5W/m
Factor de potencia	0.5
Rollo	50 m.
Tamaño del paquete	330x320x180 mm
Temperature	-30°C / +50°C
Garantía	2 Years
Peso del producto	10.750 kg./roll

Codigos EAN	6000K	SKU 4581	3800156645813
	4000K	SKU 4580	3800156645806
	2800K	SKU 4582	3800156645820
	Azul	SKU 4583	3800156645837
	Rojo	SKU 4584	3800156645844
	Verde	SKU 4585	3800156645851
	Amber	SKU 4586	3800156645868
	Amarillo	SKU 4587	3800156645875
	Rosa	SKU 4588	3800156645882
	RGB	SKU 4589	3800156645899